



Polish Nickel (Finish ID:8)

## ELLIS SURFACE MOUNT DOOR PULL

Item Code	Size (mm & Inches)	Material	Size (Inches)				Fig.
			A	B	C	D	
1 SDP.1002.12".XX.XXX.XXXX.X	304.8mm (12")	Brass	14.76	1.1	12	2.32	1
2 SDP.1002.18.XX.XXX.XXXX.X	457.2mm (18")	Brass	20.75	1.1	18	2.32	1
3 SDP.1002.24".XX.XXX.XXXX.X	609.6mm (24")	Brass	26.75	1.1	24	2.32	1
4 SDP.1002.48".XX.XXX.XXXX.X	1219.2mm (48")	Brass	50.75	1.1	48	2.32	1
5 SDP.1002.12".XX.XXX.XXXX.X	304.8mm (12")	Wood over Brass	14.76	1.1	12	2.32	1
6 SDP.1002.18.XX.XXX.XXXX.X	457.2mm (18")	Wood over Brass	20.75	1.1	18	2.32	1

"XX" in item code denotes Finish ID.

"XXX" in item code denotes Door Thickness.

"XXXX" in item code denotes Door Material.

"X" in item code denotes Front Fix or Back Fix.

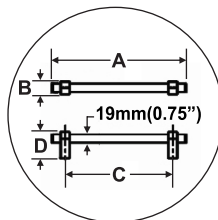
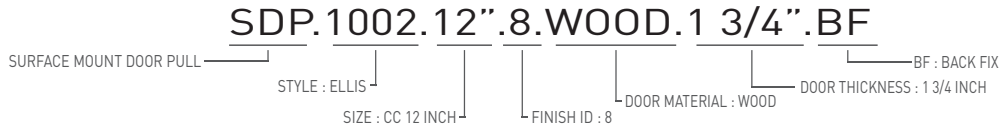



























FIG. 1

This product is Supplied with Mounting Kit including with the Order.

## How to Order



## Ellis Surface Mount Door Pull Finish Options

Base Material : Brass		Standard Finishes (2-3 Weeks Delivery)				
						
Bright Chrome (Finish ID:2)	Brush Nickel (Finish ID:3)	Aged Brass (Finish ID:4)	Unlacquered Polished Brass (Finish ID:7U)	Polished Nickel (Finish ID:8)	Satin Brass (Finish ID:13)	
Base Material : Brass		Custom Finishes (3-4 Weeks Delivery)*				
						
Lacquered Polished Brass (Finish ID:7L)	Matte Black (Finish ID:19)	Split Black and Polished Nickel (Finish ID:48)	Split Black and Satin Brass (Finish ID:49)	Split Black And Chrome (Finish ID:59)	Graphite (Finish ID:61)	Split Brush Nickel and Satin Brass (Finish ID:78)
						
Titanium (Finish ID:79)	Split Graphite and Satin Brass (Finish ID:90)	Split Graphite and Brush Chrome (Finish ID:91)	Ombre (Finish ID:92)	Brush Chrome (Finish ID:95)		
Base Material : Brass/Wood		Custom Finishes (3-4 Weeks Delivery)*				
						
Walnut Wood and Black (Finish ID:100)	Walnut Wood and Satin Brass (Finish ID:101)	Walnut Wood and Aged Brass (Finish ID:102)	Walnut Wood and Polished Nickel (Finish ID:103)	Walnut Wood and Brushed Nickel (Finish ID:104)	Beech Wood and Black (Finish ID:106)	Beech Wood and Satin Brass (Finish ID:107)
						
Beech Wood and Aged Brass (Finish ID:108)	Beech Wood and Polished Nickel (Finish ID:109)	Beech Wood and Brushed Nickel (Finish ID:110)				









- Custom finishes cannot be returned or refunded. We are unable to accept cancellations for custom finish order unless within 48 hours of the order being placed.
- We have uniform pricing for all non-hammered finishes listed above as long as base material and size is same.
- Contact us for customized finishes, refer pages F1, F2, F3 & F4 for finish glossary.

Front Fix (FF)	
Door Material	Door Thickness
1. Wood	1", 1 1/4", 1 1/2", 1 3/4", 2", 2 1/4", 2 1/2"
2. Metal	1", 1 1/4", 1 1/2", 1 3/4", 2", 2 1/4", 2 1/2"
Back Fix (BF)	
Door Material	Door Thickness
1. Wood	5/16", 3/8", 1/2", 3/4", 1", 1 1/4", 1 1/2", 1 3/4", 2", 2 1/4", 2 1/2"
2. Metal	5/16", 3/8", 1/2", 3/4", 1", 1 1/4", 1 1/2", 1 3/4", 2", 2 1/4", 2 1/2"
3. Glass	5/16", 3/8", 1/2", 3/4", 1"

- Custom finishes cannot be returned or refunded. We are unable to accept cancellations for custom finish order unless within 48 hours of the order being placed.
- We have uniform pricing for all non-hammered finishes listed above as long as base material and size is same.
- Contact us for customized finishes, refer pages F1, F2, F3 & F4 for finish glossary.







**Ellis Surface Mount Door Pull Split Finish**

**SDP.1002.XX.XX**

FINISH CODE (XX)	FINISH NAME	LINE DRAWING	A	B
SDP.1002.XX.48	Split Black and Polished Nickel		Matte Black	Polished Nickel
SDP.1002.XX.49	Split Black and Satin Brass		Matte Black	Satin Brass
SDP.1002.XX.59	Split Black and Chrome		Matte Black	Bright Chrome
SDP.1002.XX.78	Split Brush Nickel and Satin Brass		Brush Nickel	Satin Brass
SDP.1002.XX.90	Split Graphite and Satin Brass		Graphite	Satin Brass
SDP.1002.XX.91	Split Graphite and Brush Chrome		Graphite	Brush Chrome
SDP.1002.XX.100	Walnut Wood and Black		Walnut Wood	Matte Black
SDP.1002.XX.101	Walnut Wood and Satin Brass		Walnut Wood	Satin Brass

**Ellis Surface Mount Door Pull Split Finish**

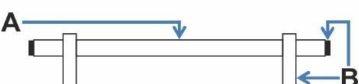
**SDP.1002.XX.XX**

FINISH CODE (XX)	FINISH NAME	LINE DRAWING	A	B
SDP.1002.XX.102	Walnut Wood and Aged Brass		Walnut Wood	Aged Brass
SDP.1002.XX.103	Walnut Wood and Polished Nickel		Walnut Wood	Polished Nickel
SDP.1002.XX.104	Walnut Wood and Brushed Nickel		Walnut Wood	Brushed Nickel
SDP.1002.XX.106	Beech Wood and Black		Beech Wood	Matte Black
SDP.1002.XX.107	Beech Wood and Satin Brass		Beech Wood	Satin Brass
SDP.1002.XX.108	Beech Wood and Aged Brass		Beech Wood	Aged Brass
SDP.1002.XX.109	Beech Wood and Polished Nickel		Beech Wood	Polished Nickel
SDP.1002.XX.110	Beech Wood and Brushed Nickel		Beech Wood	Brushed Nickel

**SURFACE MOUNT FRONT FIXING  
HANDLE ILLUSTRATED**

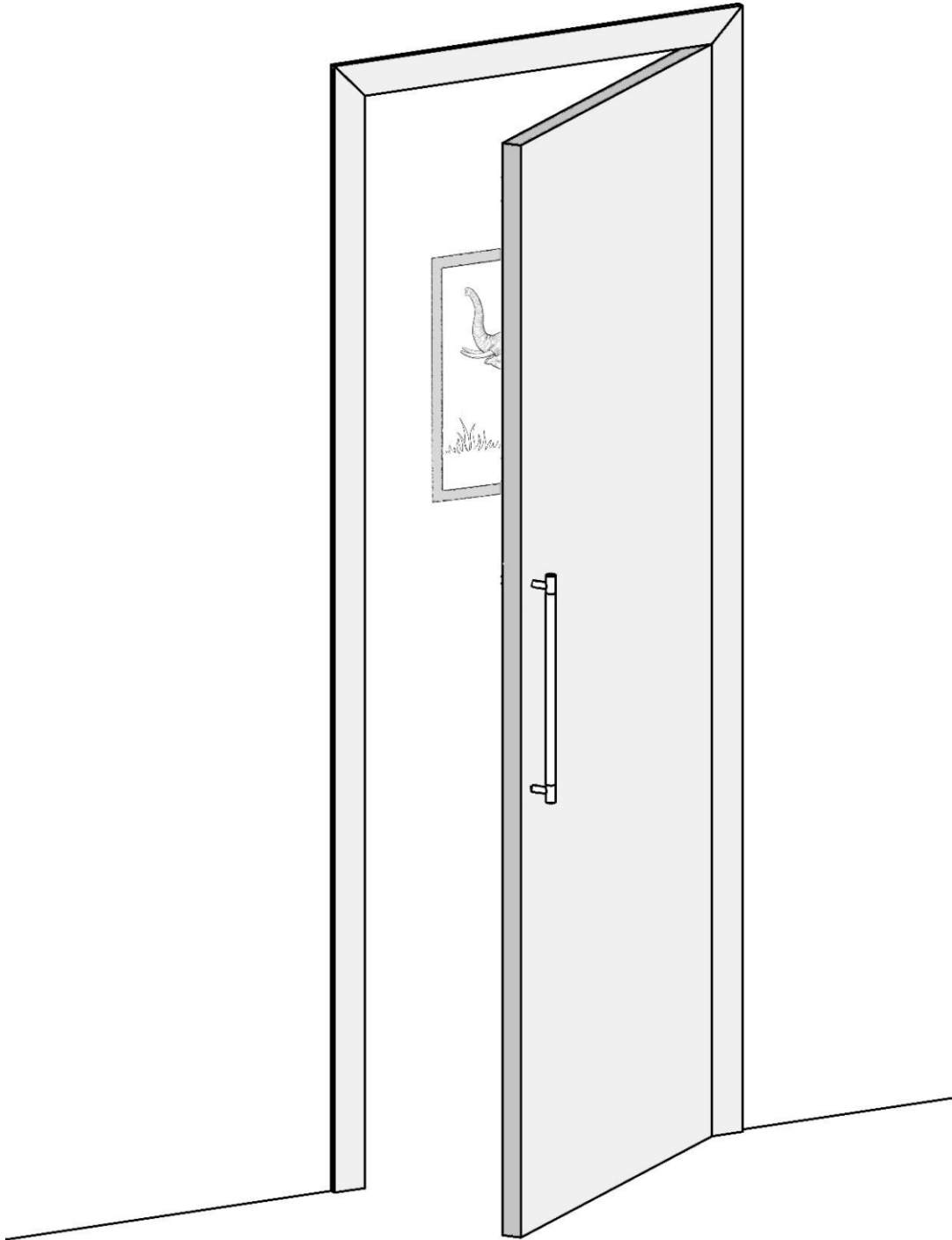

Required Tools

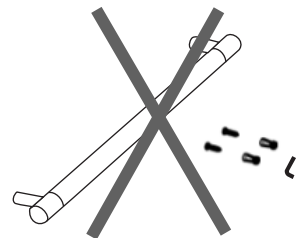
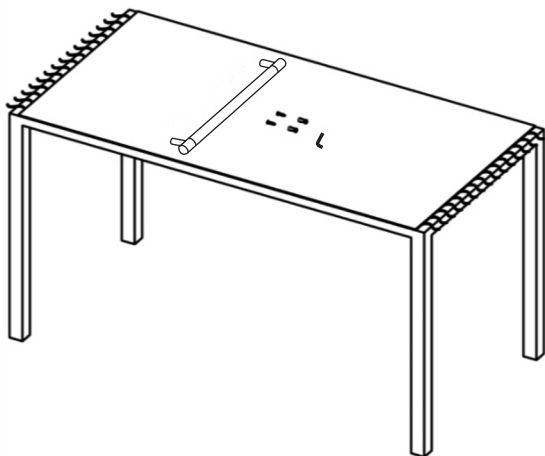
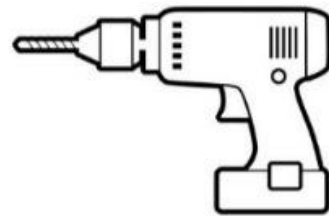
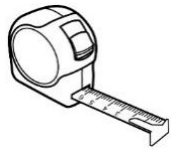

Step Wise Packing List			
S. No.	Part Number	Qty.	Steps
1	SDP.1002.XX.XX.XXX.XXXX.X	1x	1
2	SDP.FFPIN	2x	3
3	WSSCSKPFH.XX	2x	3
4	LNKY. 2.5	1x	4
5	Manual	1x	-

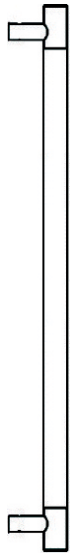
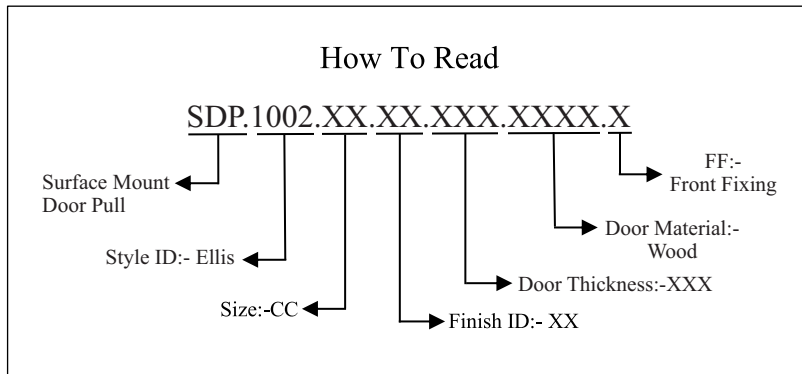

SDP.1002.XX.XX.XXX.XXXX.X



SDP.FFPIN



WSSCSKPFH.XX



LNKY. 2.5



STEP-1

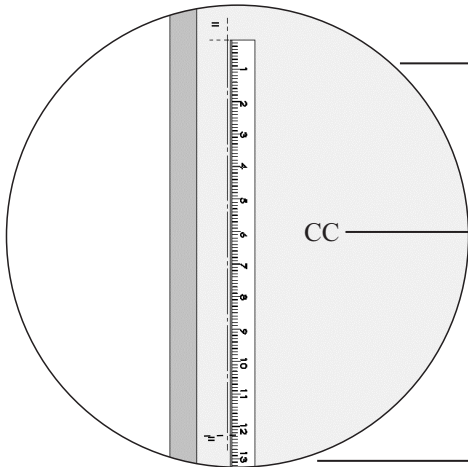
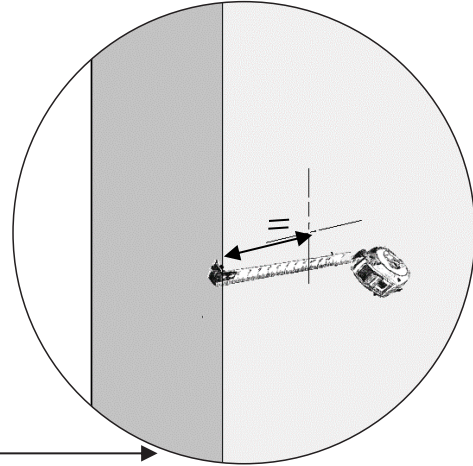
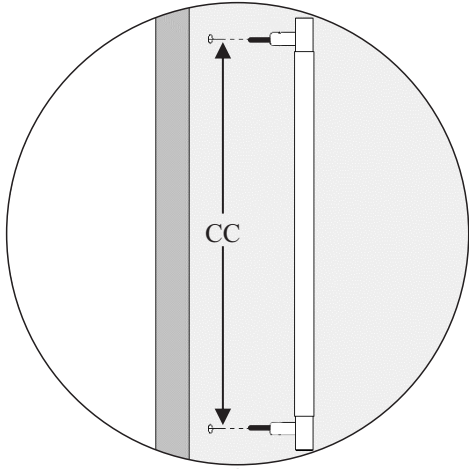

SDP.1002.XX.XX.XXX.XXXX.X

Size:-CC

- 12"
- 18"
- 24"
- 48"

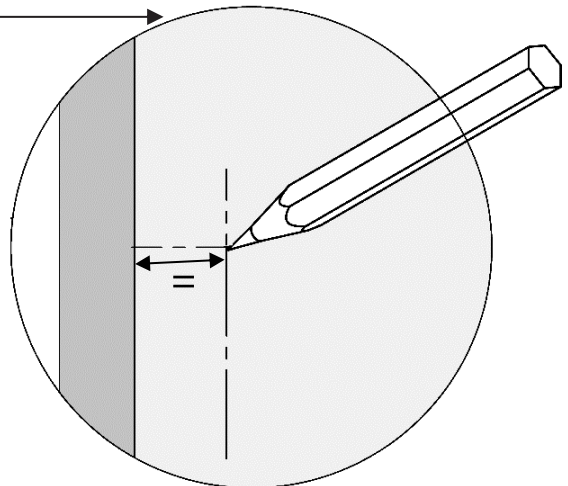
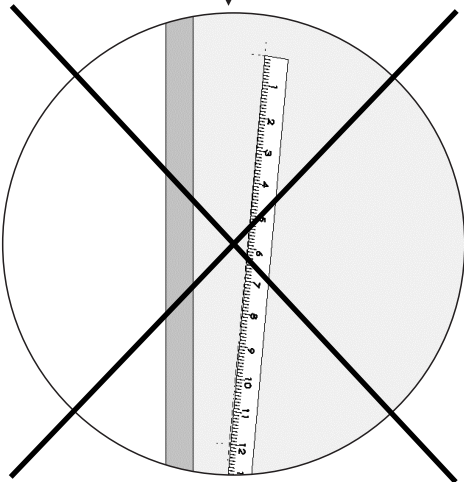

STEP-2

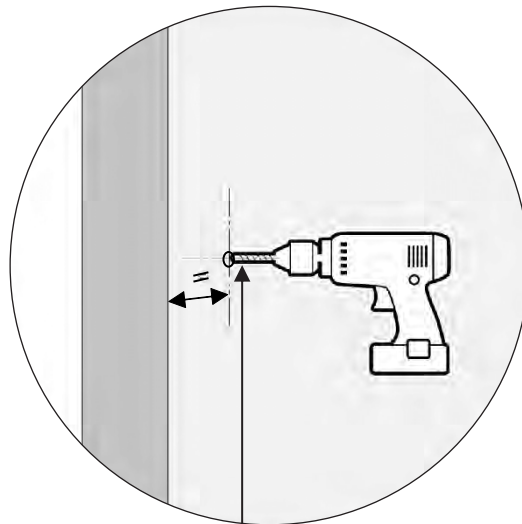
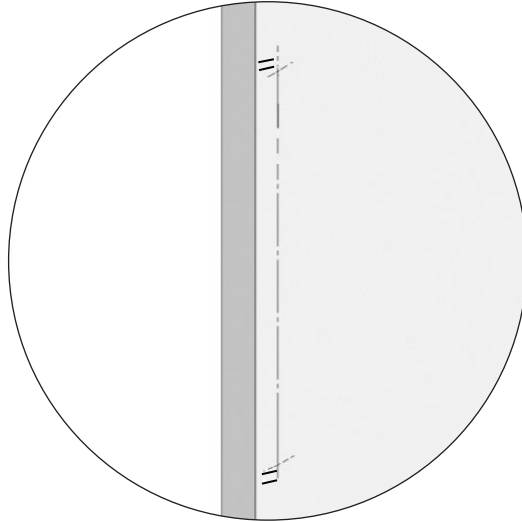

DRILL SIZE			
	Glass	Wood	Metal
SDP FF	N/A	1/10" (2.5mm)	N/A

STEP-3

Step Wise Packing List			
S. No.	Part Number	Qty.	Steps
2	SDP.FFPIN	2x	3
3	WSSCSKPFH.XX	2x	3

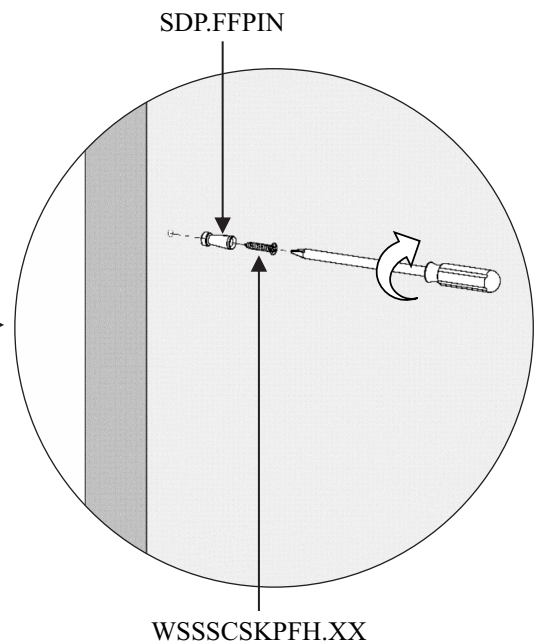
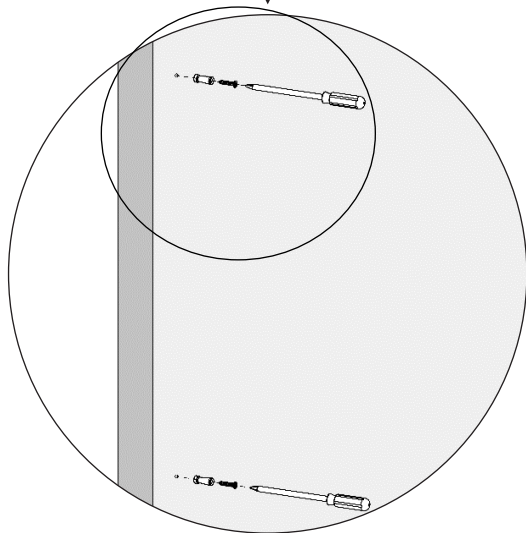
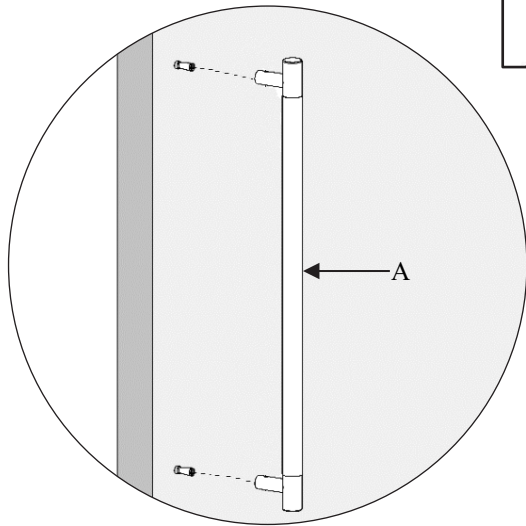
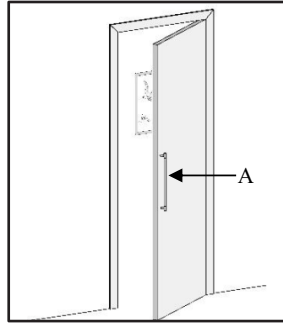

STEP-4

Step Wise Packing List			
S. No.	Part Number	Qty.	Steps
4	LNKY. 2.5	1x	4

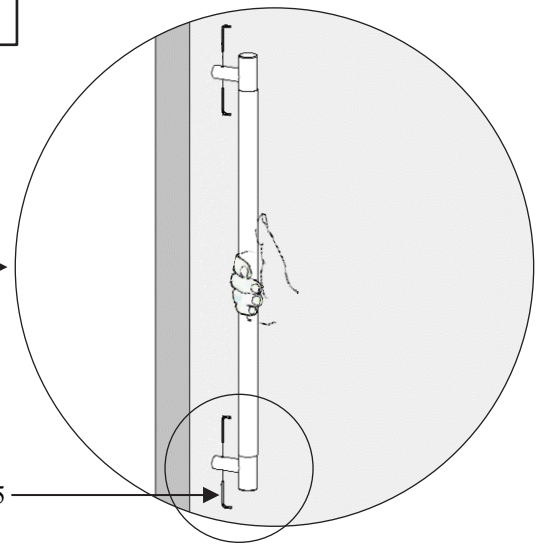
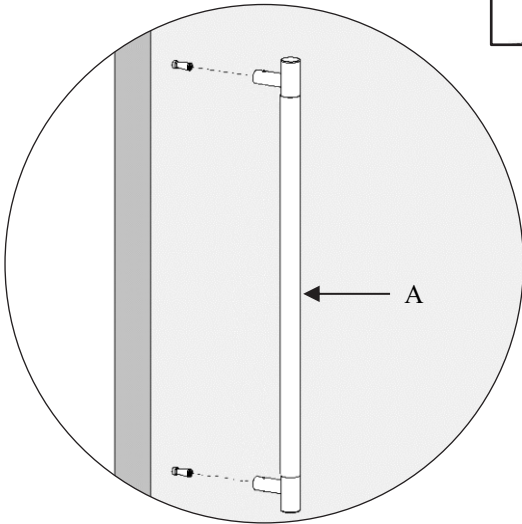
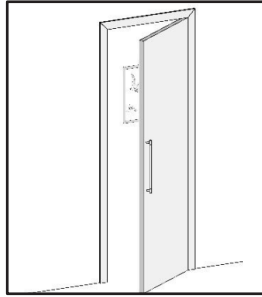

LNKY.2.5

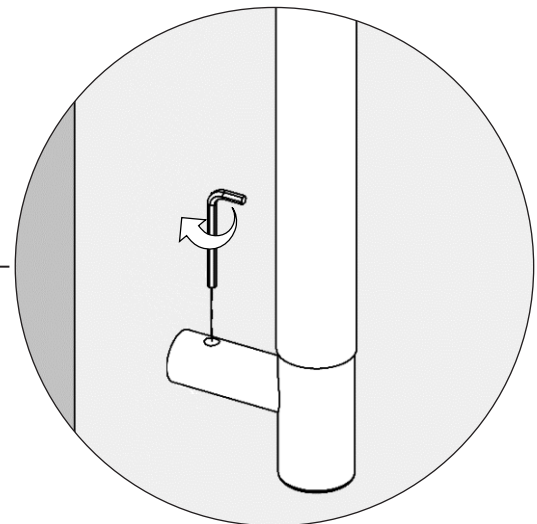
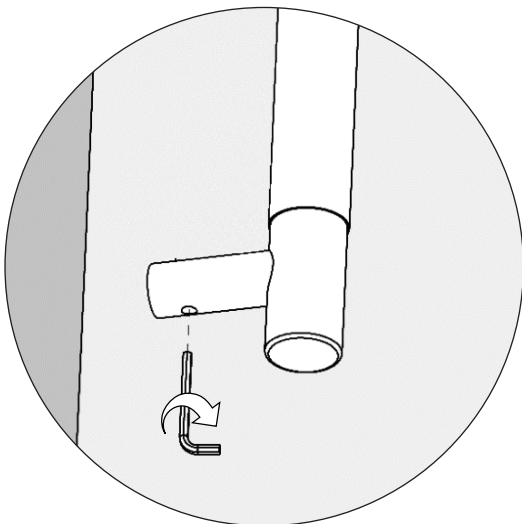

**SURFACE MOUNT BACK FIXING  
HANDLE ILLUSTRATED**

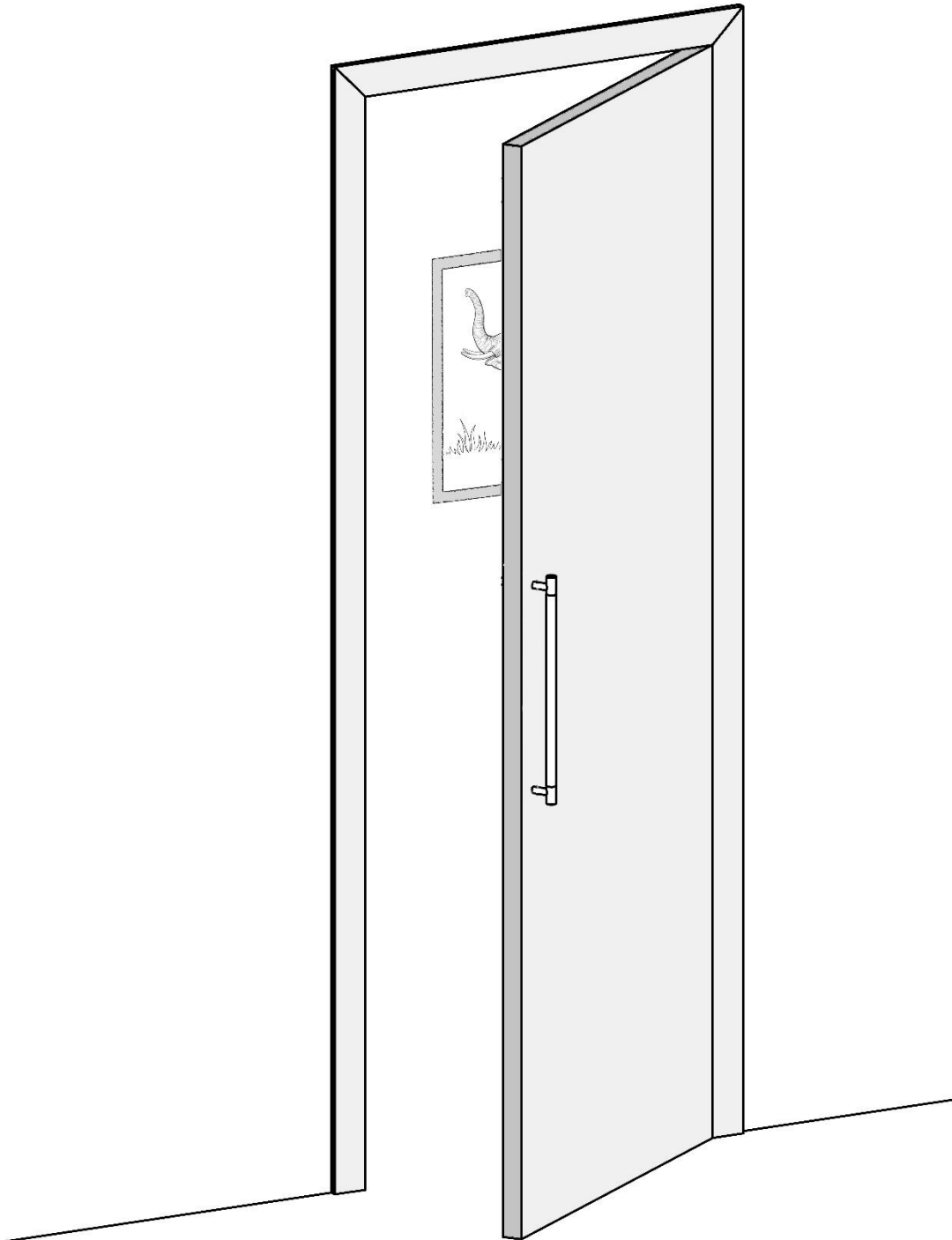

Required Tools

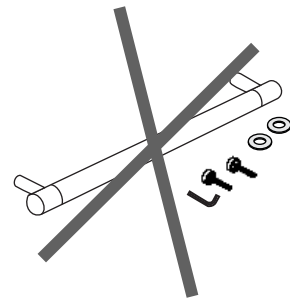
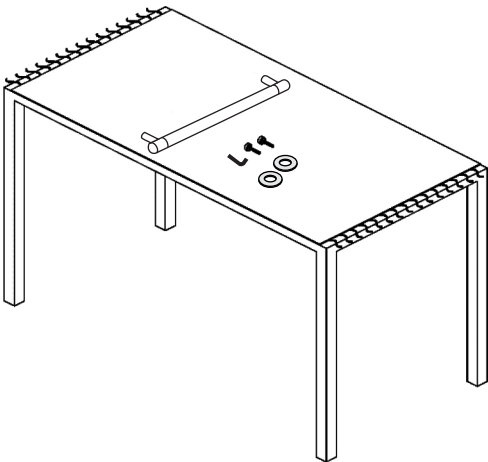
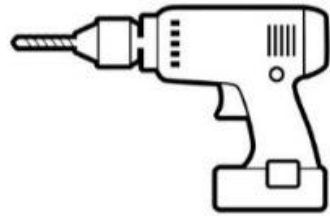
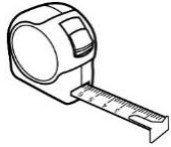
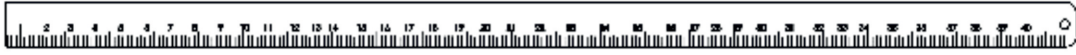

Step Wise Packing List			
S. No.	Part Number	Qty.	Steps
1	SDP.1002.XX.XX.XXX.XXXX.X	1x	1
2	SLEEVE	1x	3
3	MSCCSKPH.XX	2x	3
4	SDP.BUSH	2x	3
5	LNKY.4	1x	3
6	WASHER	2x	3
7	SDP.CAP	2x	4
8	Manual	1x	-

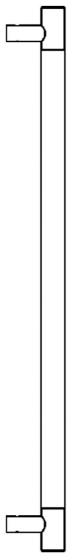
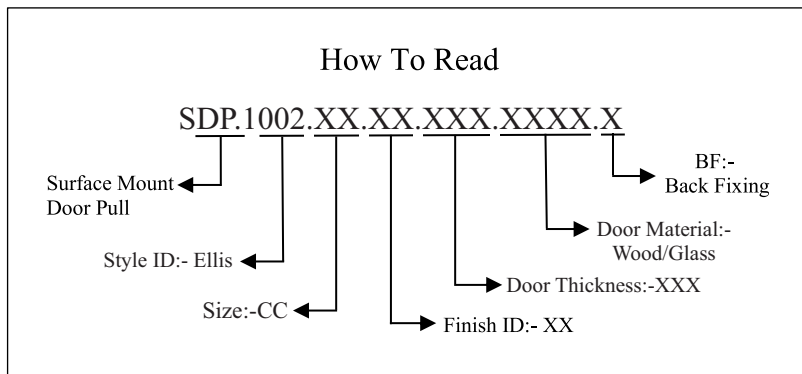

SDP.1002.XX.XX.XXX.XXXX.X



MSCCSKPH.XX



SDP.BUSH



LNKY 4

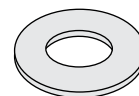

WASHER



SDP.CAP



STEP-1

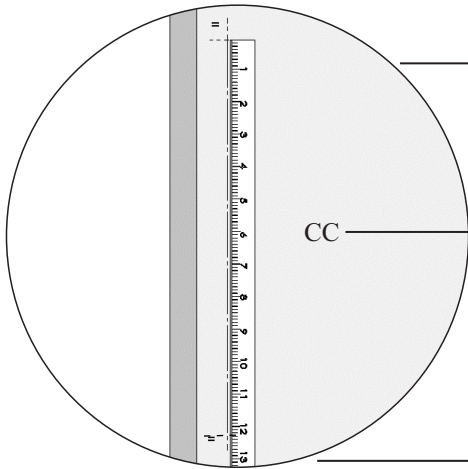
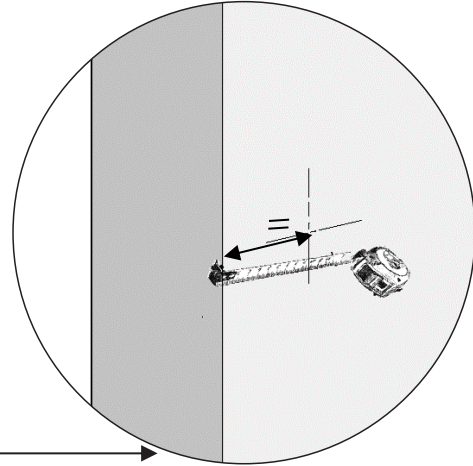
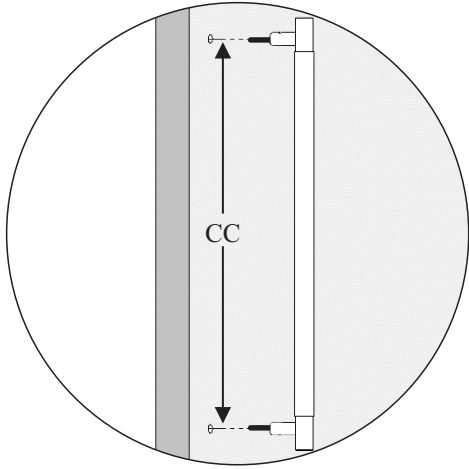

SDP.1002.XX.XX.XXX.XXXX.X

Size:-CC

- 12"
- 18"
- 24"
- 48"

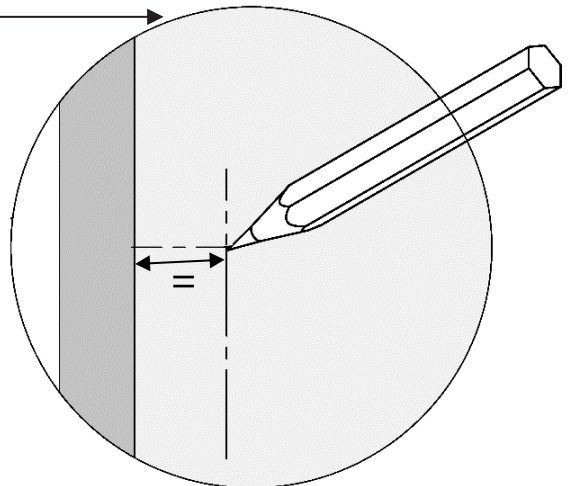
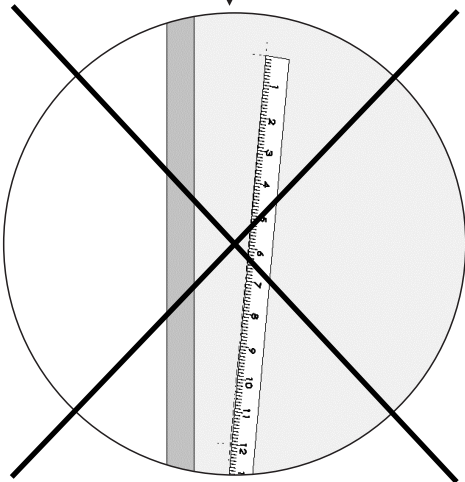



STEP-2

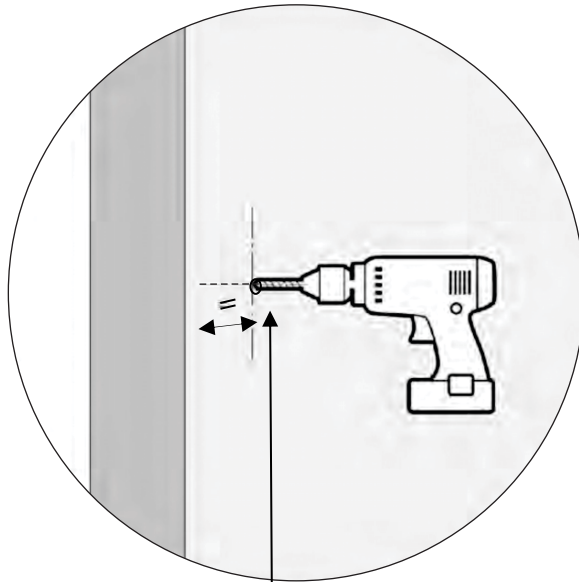
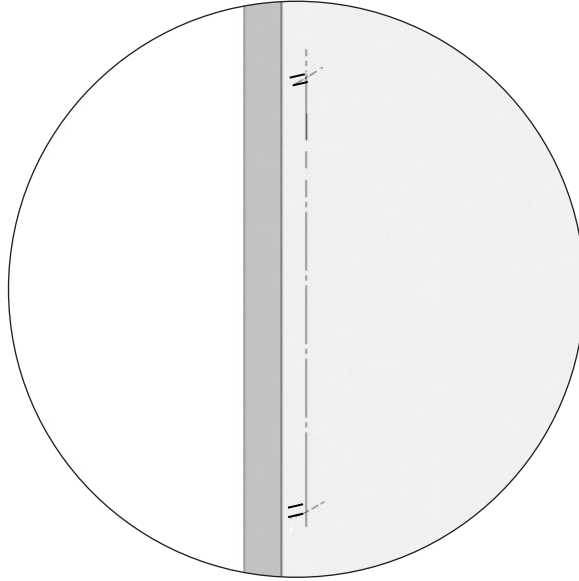

DRILL SIZE			
	Glass	Wood	Metal
<b>SDP BF</b>	3/8" (9.5mm)	1/4" (6.4mm)	1/4" (6.4mm)

STEP-3

Step Wise Packing List			
S.No.	Part Number	Qty	Steps
2	SLEEVE	1x	3
3	MSCCSKPH.XX	2x	3
4	SDP.BUSH	2x	3
5	LNKY .4	1x	3
6	WASHER	2x	3

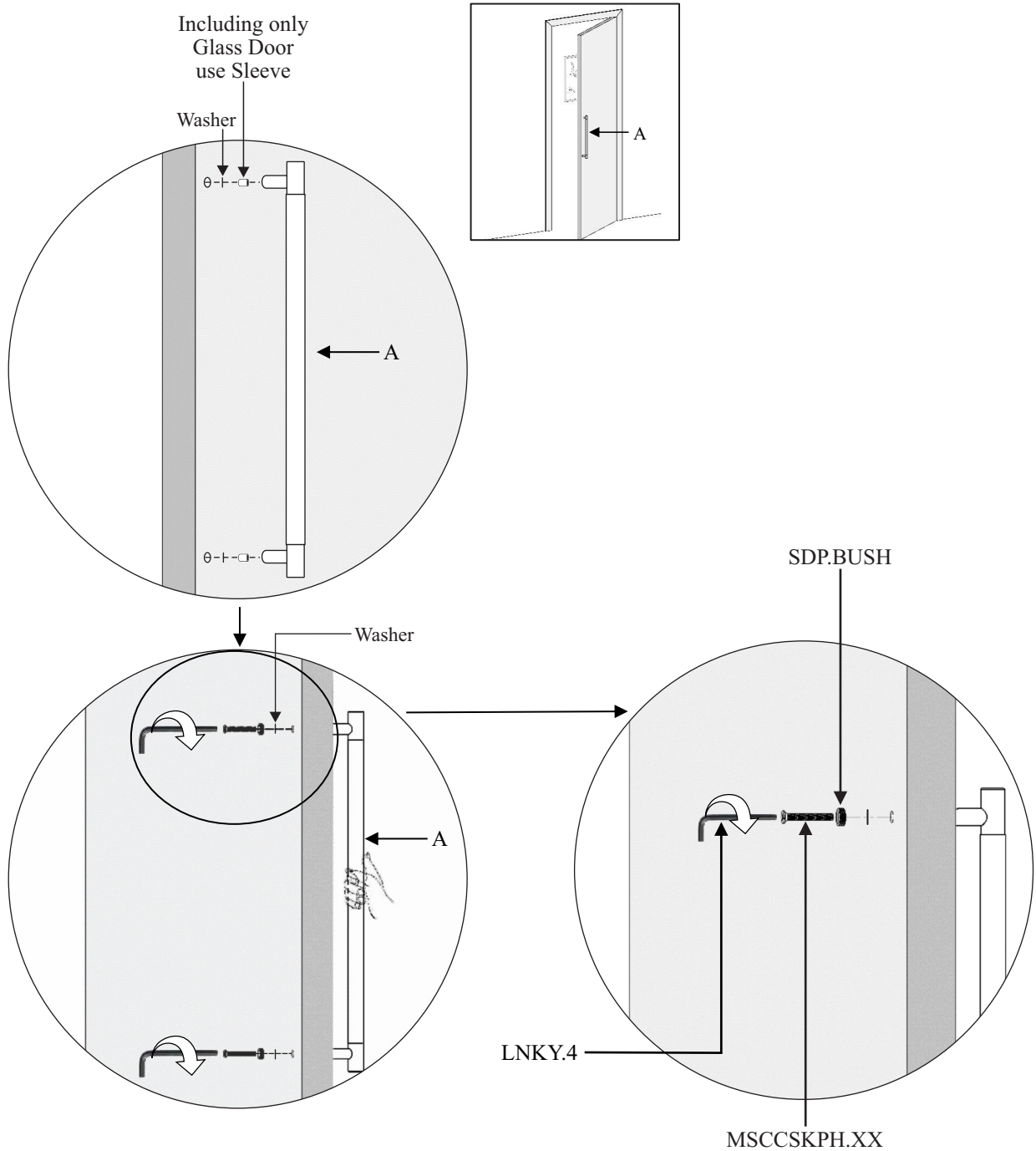

STEP-4

Step Wise Packing List			
S.No.	Part Number	Qty	Steps
7	SDP.CAP	2x	4

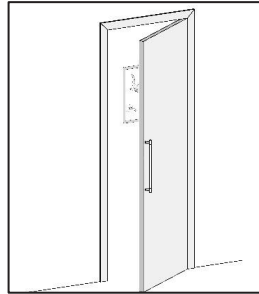

SDP.CAP

