



Split Aged Brass And English Metallic Bronze With Aged Brass Back Plate (Finish ID:75A)

LEXINGTON EASEL

	Item Code	Size (mm & Inches)	Material	Size (Inches)				Fig.
				A	B	C	D	
1	ESL.916.7".XX	177.8mm (7")	Brass	7	5	1.34	2.83	1
2	ESL.916.10".XX	254mm (10")	Brass	10	5.91	1.97	3.43	1

"XX" in item code denotes Finish ID.

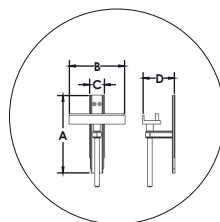

FIG. 1









This product is Supplied with wooden screws.

How to Order

ESL.916.7".75A

EASEL STYLE : LEXINGTON SIZE: 7 INCH FINISH ID : 75A

Lexington Easel Finish Options

Base Material : Brass		Standard Finishes (2-3 Weeks Delivery)			
					
Brush Nickel (Finish ID:3)	Polished Nickel (Finish ID:8)	Satin Brass (Finish ID:13)			
Base Material : Brass		Custom Finishes (3-4 Weeks Delivery)*			
					
Matte Black (Finish ID:19)	Split Black and Satin Brass with Satin Brass Back Plate (Finish ID:49A)	Split Black and Satin Brass with Black Back Plate (Finish ID:49B)	Split Aged Brass and English Metallic Bronze with Aged Brass Back Plate (Finish ID:75A)	Split Aged Brass and English Metallic Bronze with English Metallic Bronze Back Plate (Finish ID:75B)	Split Brush Nickel and Satin Brass with Satin Brass Back Plate (Finish ID:78A)

- Custom finishes cannot be returned or refunded. We are unable to accept cancellations for custom finish order unless within 48 hours of the order being placed.
- We have uniform pricing for all non-hammered finishes listed above as long as base material and size is same.
- Contact us for customized finishes, refer pages F1, F2, F3 & F4 for finish glossary.

Lexington Easel Split Finish

ESL.916.XX.XX

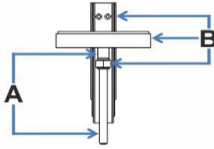
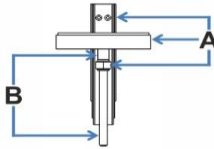
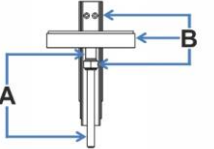
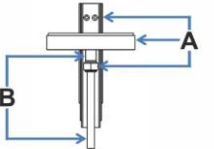
FINISH CODE (XX)	FINISH NAME	LINE DRAWING	A	B
ESL.916.XX.49A	Split Black and Satin Brass with Satin Brass Back Plate		Matte Black	Satin Brass
ESL.916.XX.49B	Split Black and Satin Brass with Black Back Plate		Matte Black	Satin Brass
ESL.916.XX.75A	Split Aged Brass and English Metallic Bronze with Aged Brass Back Plate		English Metallic Bronze	Aged Brass
ESL.916.XX.75B	Split Aged Brass and English Metallic Bronze with English Metallic Bronze Back Plate		English Metallic Bronze	Aged Brass

Easel Illustrated

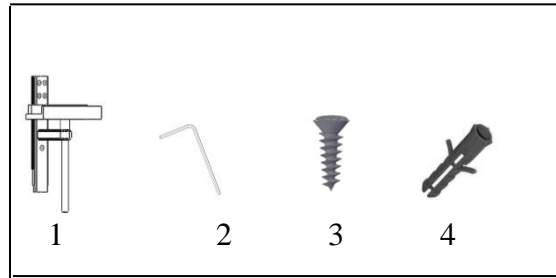
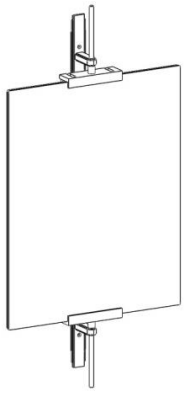

Step Wise Packing List			
S.No.	PART NO.	QTY.	STEPS
1	U Clamp Bkt.	2x	-
2	Allen Key 2mm and 3mm	1x+1x	
3	Screw #8x32	10x	
4	Anchor Fastener	10x	
5	Assemble	-	1

STEP-1

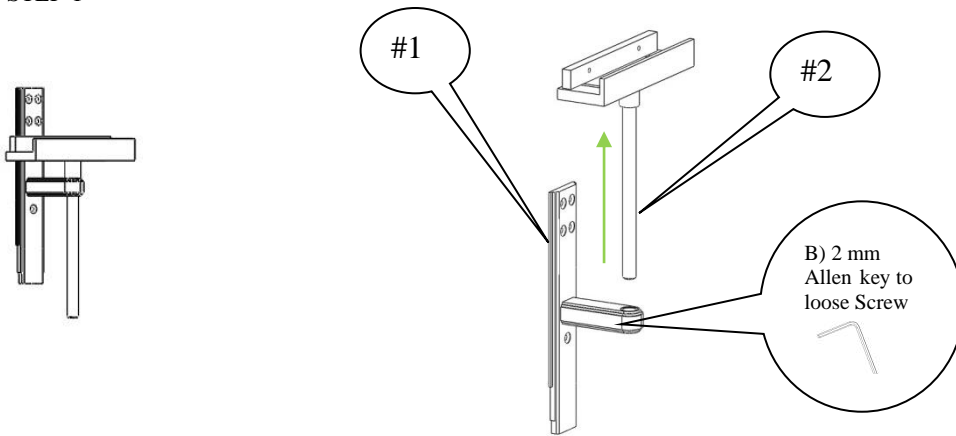

STEP-2

*A(1052mm)=Mirror frame Height(916mm) +136 mm
 *X=*A/2= (1052/2=526mm)

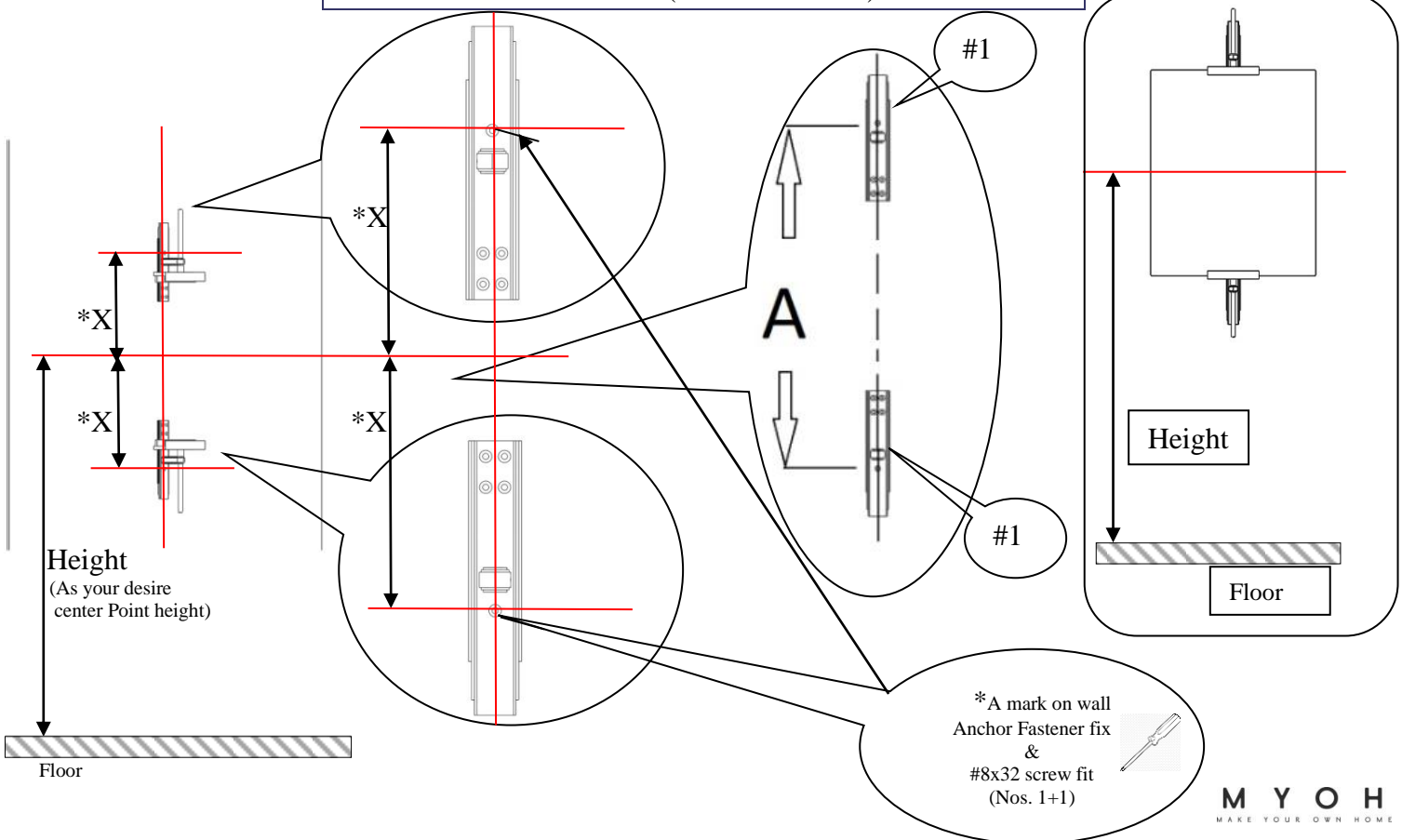

STEP-3

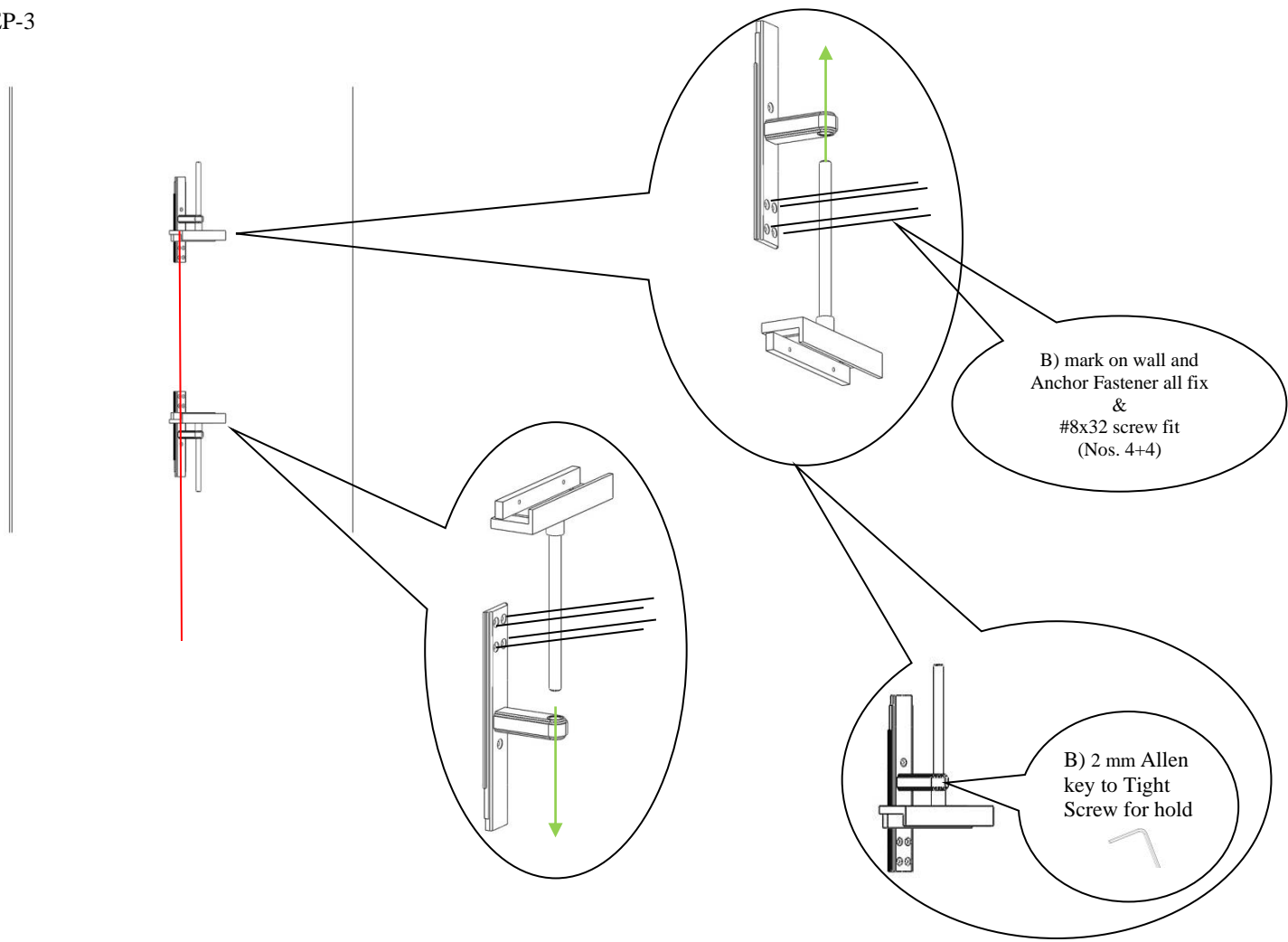

STEP-4

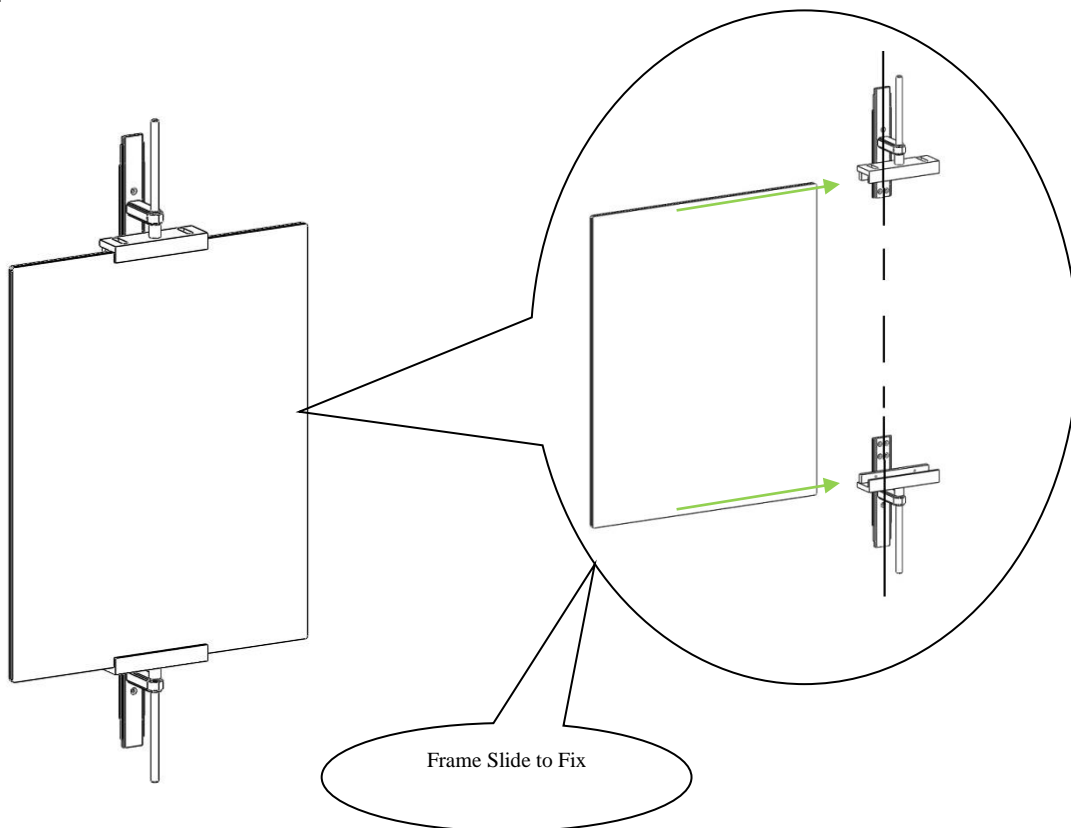

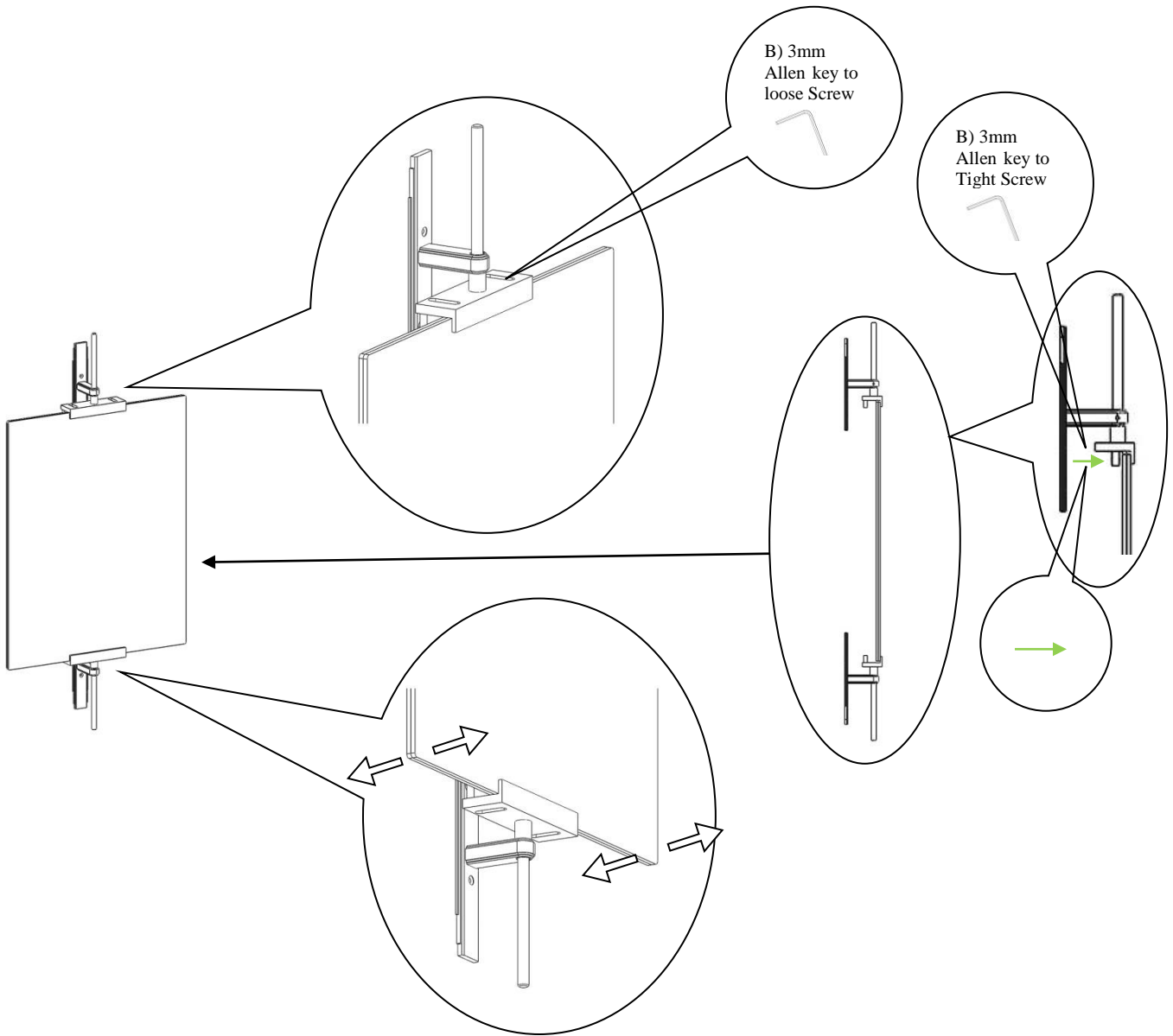

STEP-6

