



Polish Nickel (Finish ID:8)

ELLIS BACK TO BACK DOOR PULL

	Item Code	Size (mm & Inches)	Material	Size (Inches)				Fig.
				A	B	C	D	
1	DDP.1002.12".XX.XXX.XXXX	304.8mm (12")	Brass	14.76	1.1	12	2.32	1
2	DDP.1002.18.XX.XXX.XXXX	457.2mm (18")	Brass	20.75	1.1	18	2.32	1
3	DDP.1002.24".XX.XXX.XXXX	609.6mm (24")	Brass	26.75	1.1	24	2.32	1
4	DDP.1002.48".XX.XXX.XXXX	1219.2mm (48")	Brass	50.75	1.1	48	2.32	1
5	DDP.1002.12".XX.XXX.XXXX	304.8mm (12")	Wood over Brass	14.76	1.1	12	2.32	1
6	DDP.1002.18.XX.XXX.XXXX	457.2mm (18")	Wood over Brass	20.75	1.1	18	2.32	1

"XX" in item code denotes Finish ID.
 "XXX" in item code denotes Door Thickness.
 "XXXX" in item code denotes Door Material.

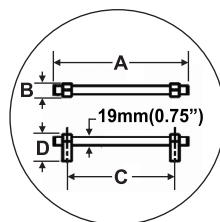
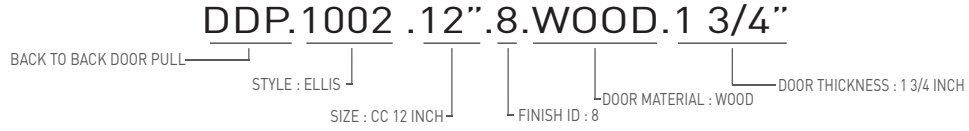





























FIG. 1

This product is Supplied with Mounting Kit including with the Order.

How to Order



Ellis Back To Back Door Pull Finish Options

Base Material : Brass		Standard Finishes (2-3 Weeks Delivery)				
						
Bright Chrome (Finish ID:2)	Brush Nickel (Finish ID:3)	Aged Brass (Finish ID:4)	Unlacquered Polished Brass (Finish ID:7U)	Polished Nickel (Finish ID:8)	Satin Brass (Finish ID:13)	
Base Material : Brass		Custom Finishes (3-4 Weeks Delivery)*				
						
Lacquered Polished Brass (Finish ID:7L)	Matte Black (Finish ID:19)	Split Black and Polished Nickel (Finish ID:48)	Split Black and Satin Brass (Finish ID:49)	Split Black And Chrome (Finish ID:59)	Graphite (Finish ID:61)	Split Brush Nickel and Satin Brass (Finish ID:78)
						
Titanium (Finish ID:79)	Split Graphite and Satin Brass (Finish ID:90)	Split Graphite and Brush Chrome (Finish ID:91)	Ombre (Finish ID:92)	Brush Chrome (Finish ID:95)		
Base Material : Brass/Wood		Custom Finishes (3-4 Weeks Delivery)*				
						
Walnut Wood and Black (Finish ID:100)	Walnut Wood and Satin Brass (Finish ID:101)	Walnut Wood and Aged Brass (Finish ID:102)	Walnut Wood and Polished Nickel (Finish ID:103)	Walnut Wood and Brushed Nickel (Finish ID:104)	Beech Wood and Black (Finish ID:106)	Beech Wood and Satin Brass (Finish ID:107)
						
Beech Wood and Aged Brass (Finish ID:108)	Beech Wood and Polished Nickel (Finish ID:109)	Beech Wood and Brushed Nickel (Finish ID:110)				







- Custom finishes cannot be returned or refunded. We are unable to accept cancellations for custom finish order unless within 48 hours of the order being placed.
- We have uniform pricing for all non-hammered finishes listed above as long as base material and size is same.
- Contact us for customized finishes, refer pages F1, F2, F3 & F4 for finish glossary.

Door Material	Door Thickness
1. Wood	5/16", 3/8", 1/2", 3/4", 1", 1 1/4", 1 1/2", 1 3/4", 2", 2 1/4", 2 1/2"
2. Metal	5/16", 3/8", 1/2", 3/4", 1", 1 1/4", 1 1/2", 1 3/4", 2", 2 1/4", 2 1/2"
3. Glass	5/16", 3/8", 1/2", 3/4", 1"

- Custom finishes cannot be returned or refunded. We are unable to accept cancellations for custom finish order unless within 48 hours of the order being placed.
- We have uniform pricing for all non-hammered finishes listed above as long as base material and size is same.
- Contact us for customized finishes, refer pages F1, F2, F3 & F4 for finish glossary.

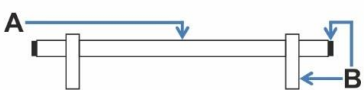







Ellis Back to Back Door Pull Split Finish

DDP.1002.XX.XX

FINISH CODE (XX)	FINISH NAME	LINE DRAWING	A	B
DDP.1002.XX.48	Split Black and Polished Nickel		Matte Black	Polished Nickel
DDP.1002.XX.49	Split Black and Satin Brass		Matte Black	Satin Brass
DDP.1002.XX.59	Split Black and Chrome		Matte Black	Bright Chrome
DDP.1002.XX.78	Split Brush Nickel and Satin Brass		Brush Nickel	Satin Brass
DDP.1002.XX.90	Split Graphite and Satin Brass		Graphite	Satin Brass
DDP.1002.XX.91	Split Graphite and Brush Chrome		Graphite	Brush Chrome
DDP.1002.XX.100	Walnut Wood and Black		Walnut Wood	Matte Black
DDP.1002.XX.101	Walnut Wood and Satin Brass		Walnut Wood	Satin Brass

Ellis Back to Back Door Pull Split Finish

DDP.1002.XX.XX

FINISH CODE (XX)	FINISH NAME	LINE DRAWING	A	B
DDP.1002.XX.102	Walnut Wood and Aged Brass		Walnut Wood	Aged Brass
DDP.1002.XX.103	Walnut Wood and Polished Nickel		Walnut Wood	Polished Nickel
DDP.1002.XX.104	Walnut Wood and Brushed Nickel		Walnut Wood	Brushed Nickel
DDP.1002.XX.106	Beech Wood and Black		Beech Wood	Matte Black
DDP.1002.XX.107	Beech Wood and Satin Brass		Beech Wood	Satin Brass
DDP.1002.XX.108	Beech Wood and Aged Brass		Beech Wood	Aged Brass
DDP.1002.XX.109	Beech Wood and Polished Nickel		Beech Wood	Polished Nickel
DDP.1002.XX.110	Beech Wood and Brushed Nickel		Beech Wood	Brushed Nickel

**BACK TO BACK
HANDLE ILLUSTRATED**

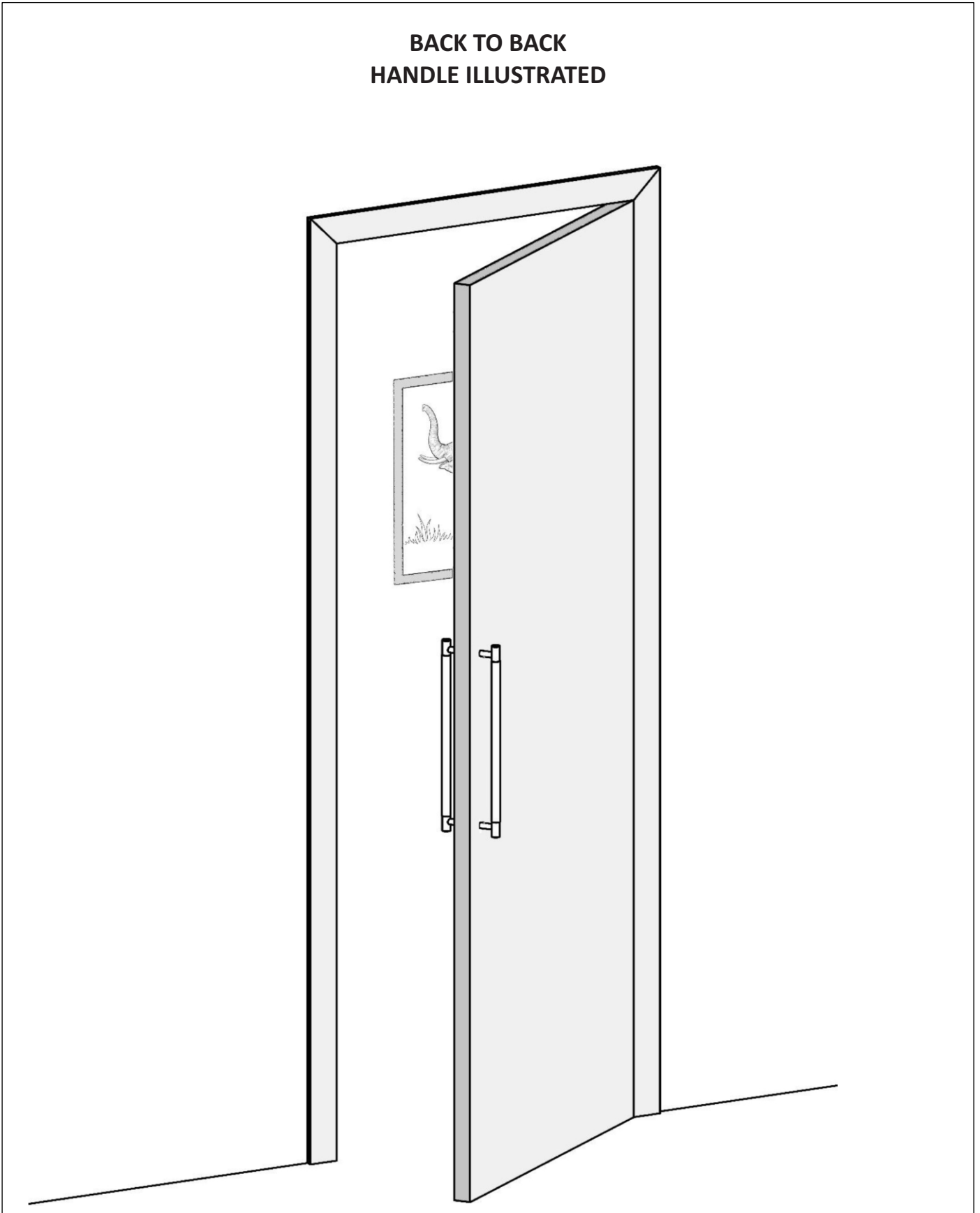

Required Tools

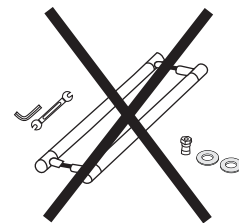
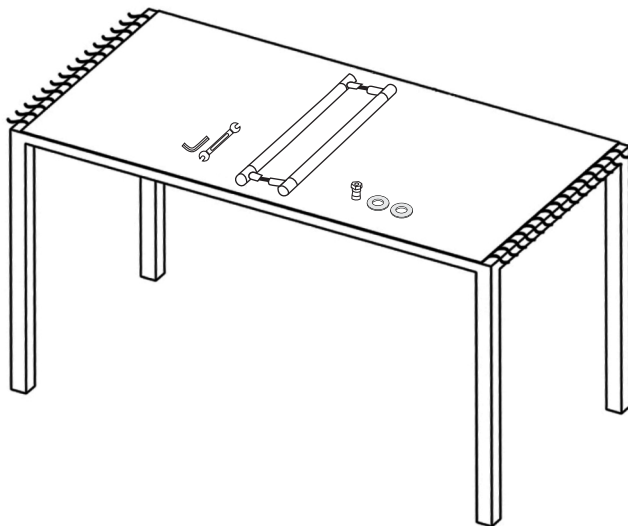
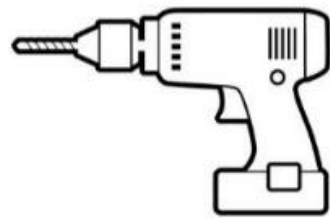
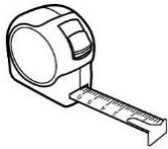

Step Wise Packing List			
S.No.	Part Number	Qty	Steps
1	DDP.1002.XX.XX.XXX.XXXX	1x	1
2	SLEEVE	1x	1
3	LNKY2.5	1x	1
4	INSERT	1x	1
5	WASHER	2x	1
6	DDP.SPANNER (No.10,11)	1x	4
7	Manual	1x	-

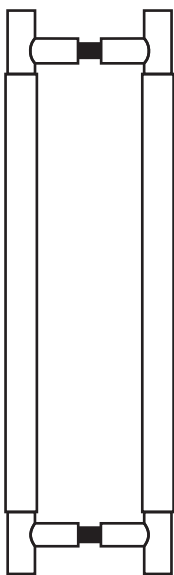
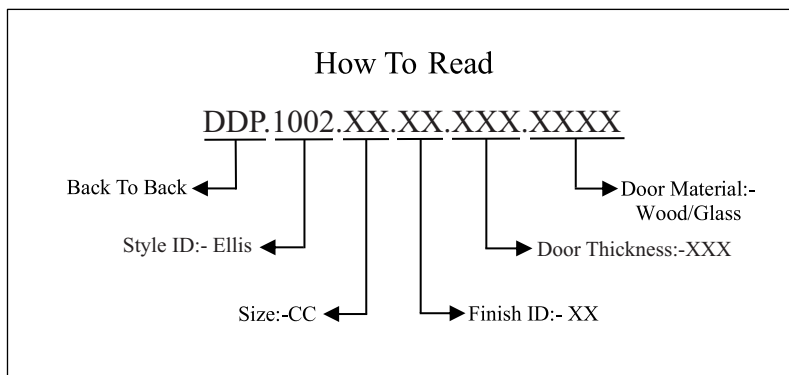

DDP.1002.XX.XX.XXX.XXXX



LNKY2.5



INSERT

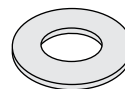

WASHER

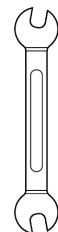

DDP.SPANNER (No.10,11)

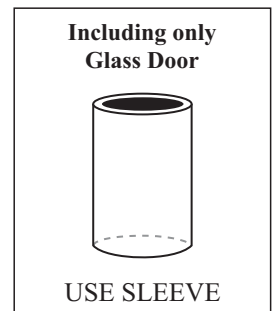

STEP-1

Step Wise Packing List			
S.No.	Part Number	Qty	Steps
1	DDP.1002.XX.XX.XXX.XXXX	1x	1
2	SLEEVE	1x	1
3	LNKY2.5	1x	1
4	INSERT	1x	1
5	WASHER	2x	1

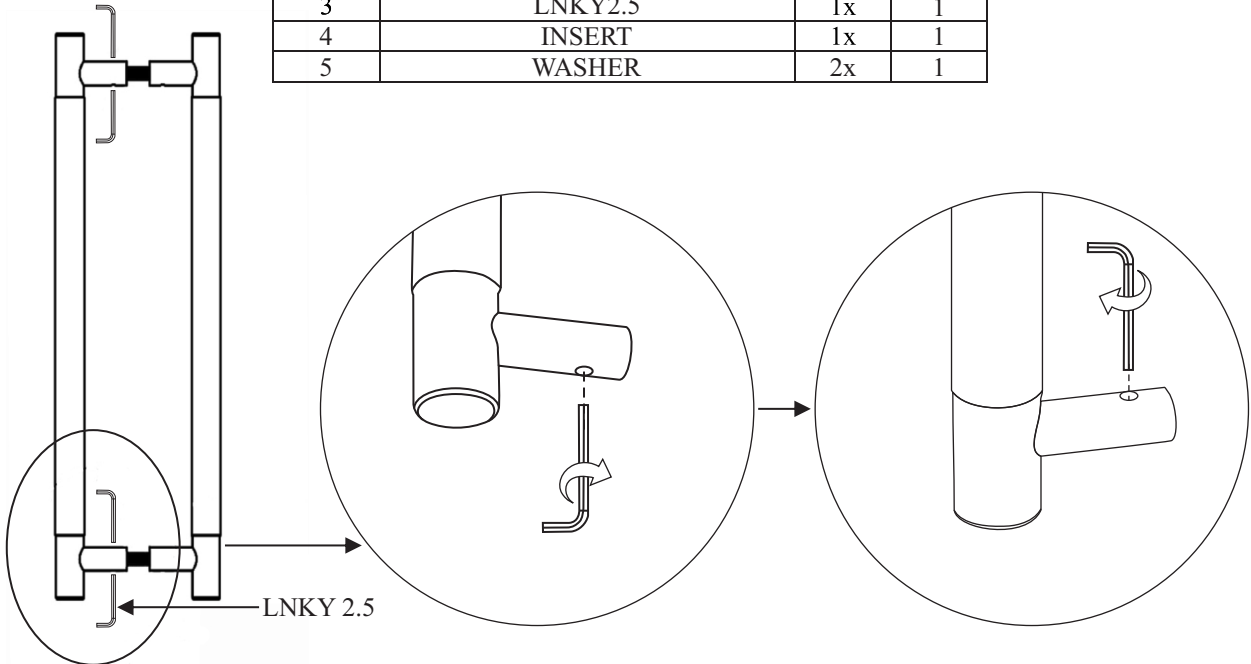

DDP.1002.XX.XX.XXX.XXXX

Including only
Glass Door
Use Sleeve

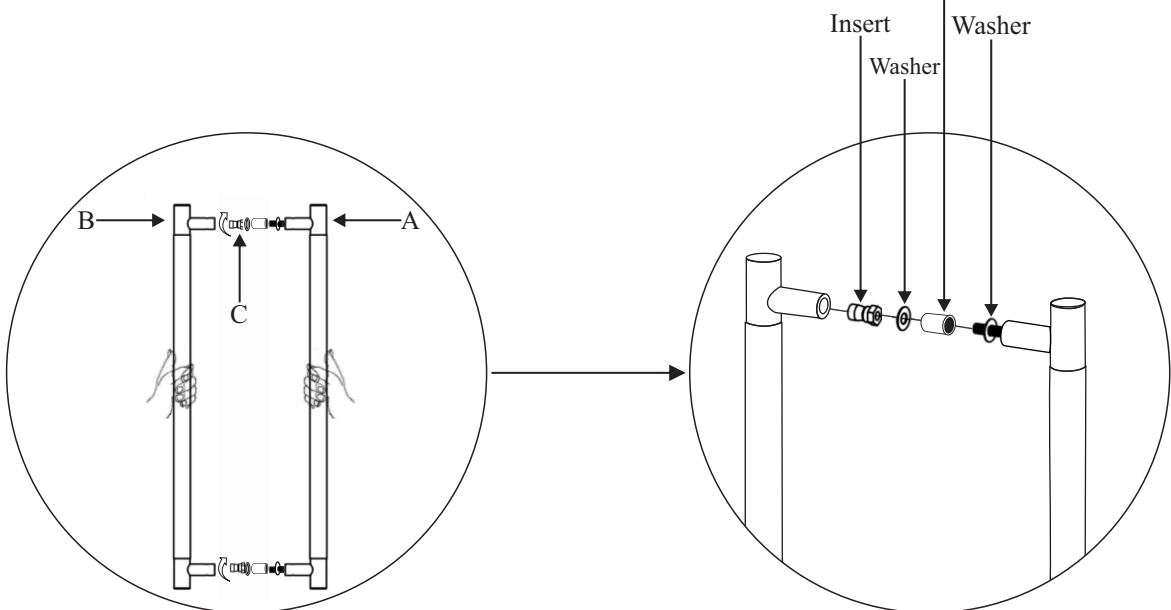

STEP-2

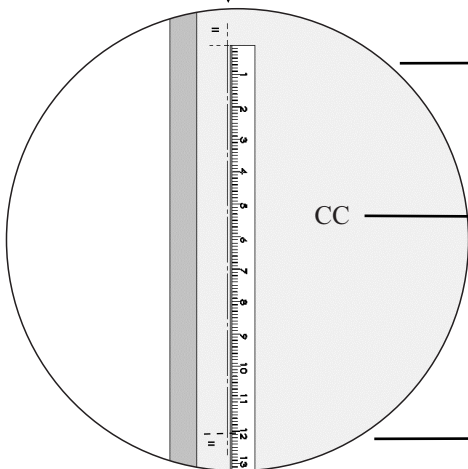
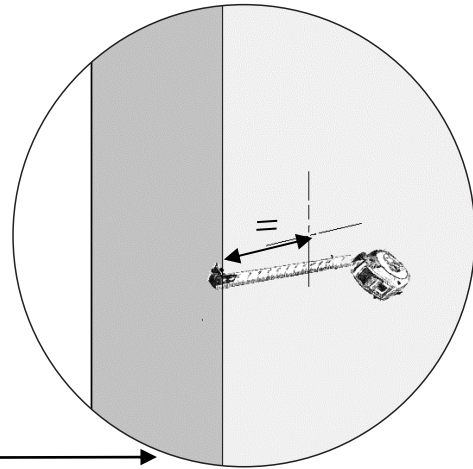
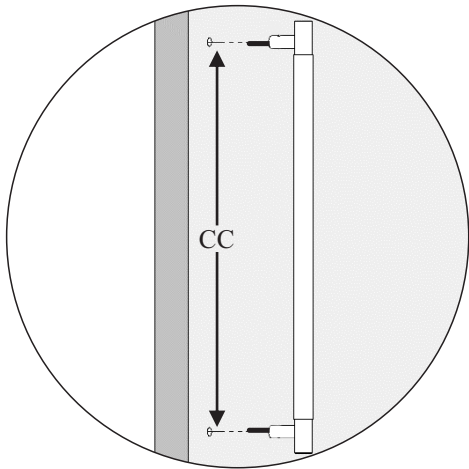

DDP.1002.XX.XX.XXX.XXXX

Size:-CC
↓
12"
18"
24"
48"

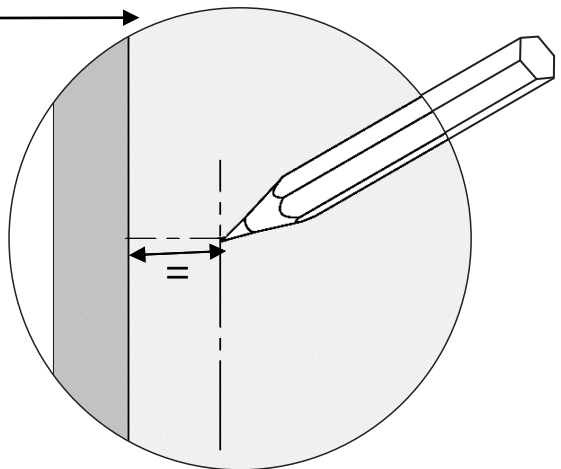
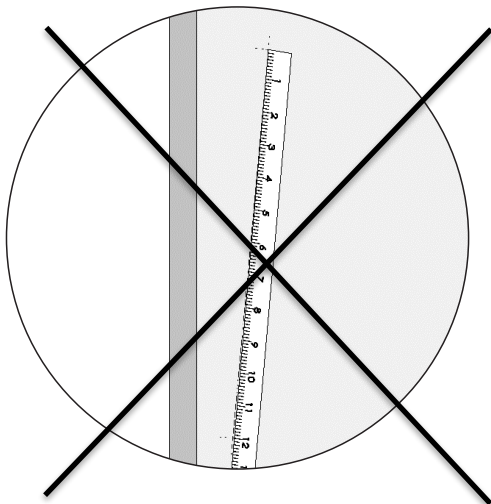

STEP-3

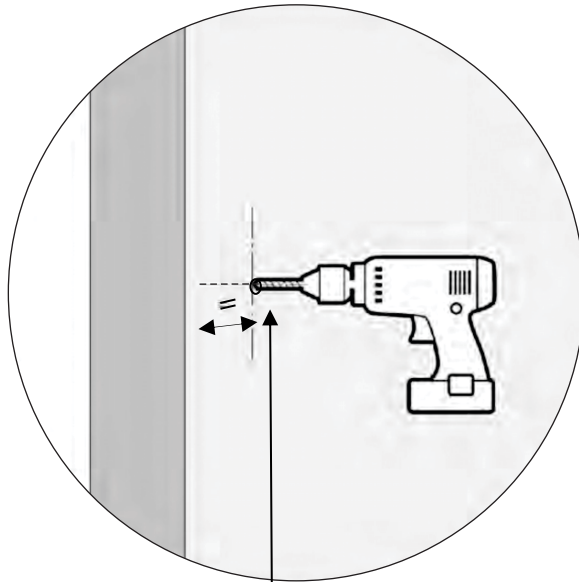
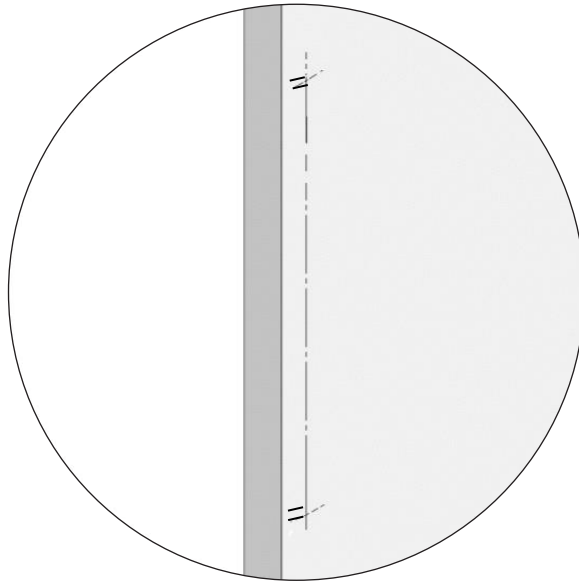

DRILL SIZE			
	Glass	Wood	Metal
DDP	3/8" (9.5mm)	1/4" (6.4mm)	1/4" (6.4mm)

STEP-4

Step Wise Packing List			
S.No.	Part Number	Qty	Steps
6	DDP.SPANNER (No.10,11)	1x	4

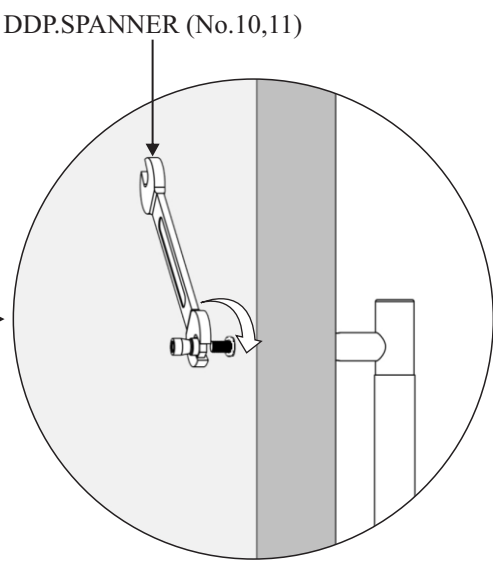
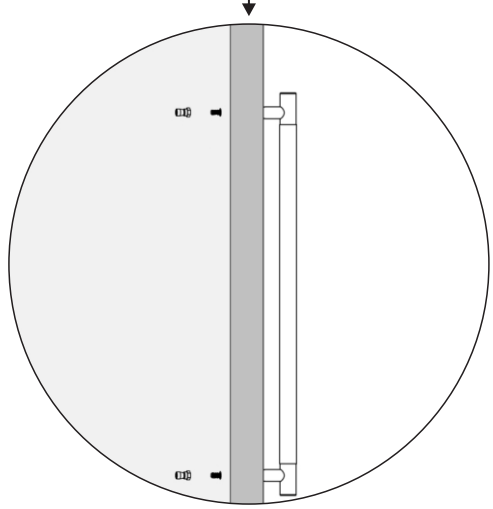
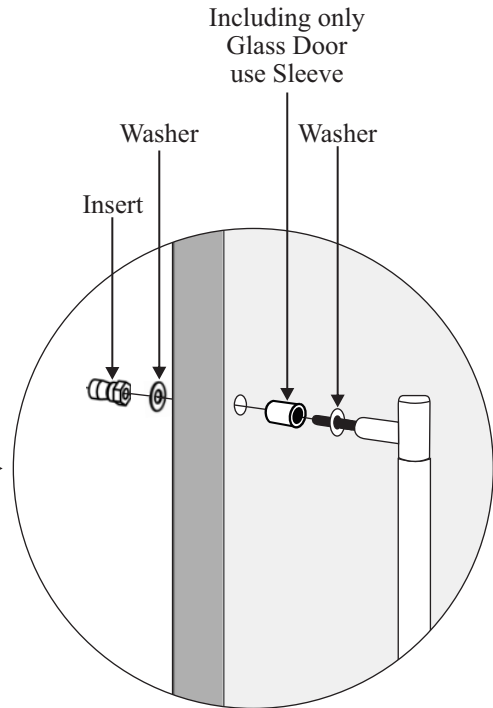
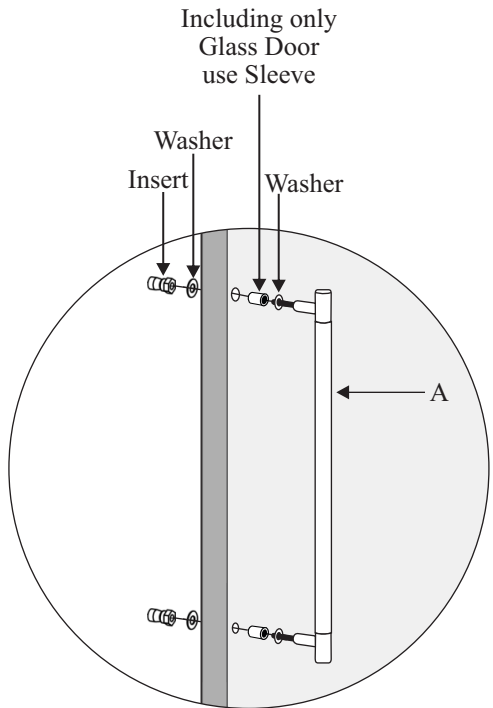
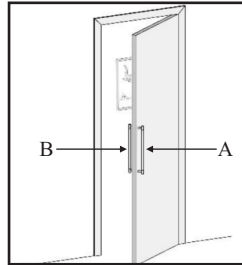

STEP-5

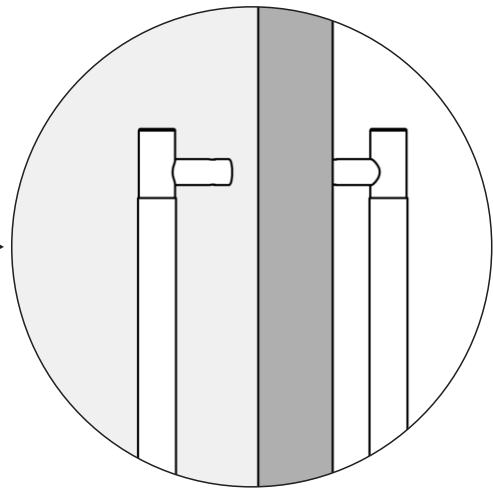
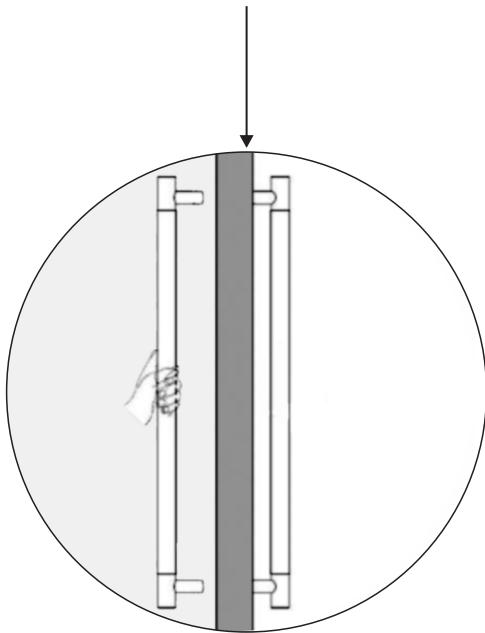
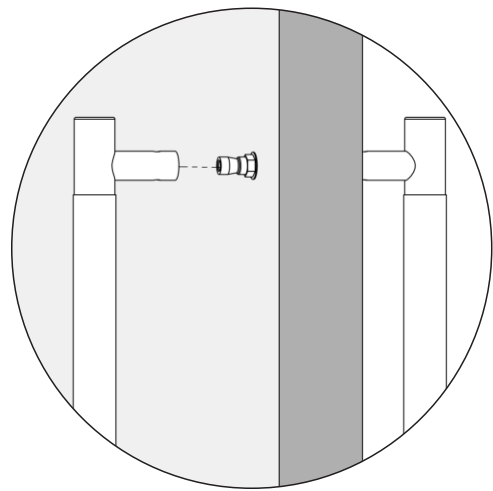
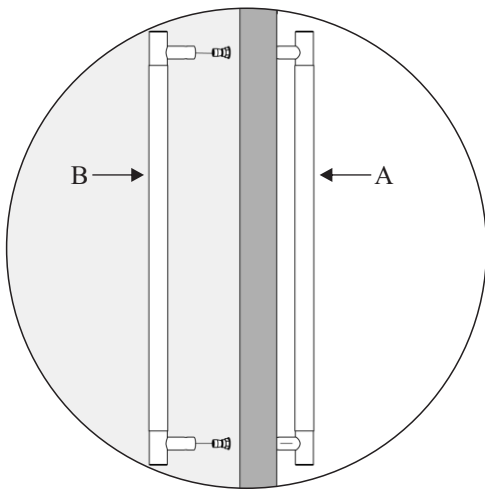
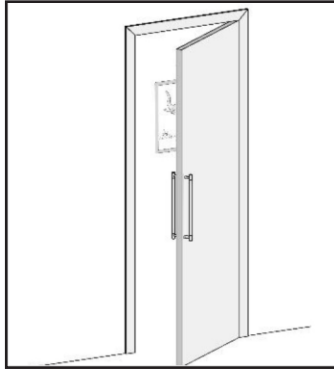

STEP-6

